

HES INSTALLATION MANUAL (IEC)

Issued on Dec. 10th, 2024 (Version1.4)

HYUNDAI ENERGY SOLUTIONS

Solution for your energy !



HJT PV MODULE INSTALLATION MANUAL

1 General Information	3
1.1 Overview	3
1.2 Installation Manual Disclaimer	3
1.3 Limitation of Liability	4
1.4 Module Identification	4
2 Unloading and Storage	4
2.1 Unloading	4
2.2 Storage	8
3 Unpack	9
3.1 Precautions	9
4 Installation	11
4.1 Fire Safety	11
4.2 Installation Safety	11
4.3 Safe Operation	13
4.4 Installation Conditions	14
4.5 Mechanical Installation of Components	15
5 Electrical Installation	24
5.1 Electrical Performance	24
5.2 Cables	25
5.3 Connectors	25
5.4 Bypass Diode	26
5.5 Anti-pid and Inverter Compatibility	26
5.6 Cable method	26
6 Grounding	28
7 Operation and Maintenance	29
7.1 Cleaning	29
7.2 Visual Inspection of Modules	31
7.3 Inspection of Connector and Cables	31

1. General Information

1.1 Overview

This general manual provides important safety information relating to the installation, maintenance and handling of heterojunction(HJT) solar modules. Professional installer must read these guidelines carefully and strictly follow these instructions. Failure to follow these instructions may result in death, injury or property damage. The installation and handling of HJTPV modules requires professional skills and should only be performed by qualified professionals. Installers must inform end-users (consumers) about the aforesaid information accordingly.

The "module" or "HJT module" in this specification refers to one or more series HJT photovoltaic modules. Please keep this manual for future reference.

It is recommended to visit the HD HYUNDAI ENERGY SOLUTIONS website www.hd-hyundaies.co.kr regularly to obtain the latest version.

1.2 Installation Manual Disclaimer

Because the use of the manual and the conditions or methods of installation, operation, use and maintenance of photovoltaic (PV) product are beyond HD HYUNDAI's control, HD HYUNDAI does not accept responsibility and expressly disclaims liability for loss ,damage, or expense arising out of or in any way connected with such installation, operation, use or maintenance.

No responsibility is assumed by HD HYUNDAI for any infringement of patents or other rights of third parties, which may result from use of the PV product. NO license is granted by implication or otherwise under any patent or patent rights.

The information in this manual is based on HD HYUNDAI's knowledge and experience and is believed to be reliable, but such information including product specification (without limitations) and suggestions do not constitute a warranty, expresses or implied. HD HYUNDAI reserve the right to change the manual, the PV produce, the specifications, or product information sheets without prior notice.

Modules qualified for safety through IEC 61730-1 and this part of IEC 61730 within this application class are considered to meet the requirements for safety class II.

1.3 Limitation of Liability

HD HYUNDAI is not responsible for any form of injury, including but not limited to module operation, system installation, and physical injury, injury and property damage caused by whether it is in accordance with the instructions in this manual.

1.4 Module Identification

Each module is affixed with 2 labels containing the following information:

1. Nameplate: contains product type, rated power, rated current, rated voltage, open circuit voltage, short circuit current, certification mark, maximum system voltage and other information. The nameplate is axed between the cable boxes on the back of the module;
2. Bar code: contains current grade, quality grade and other information. The bar code is placed inside the module before laminating. In addition, a bar code is also axed to side B of the module frame.

2. Unloading and Storage

1. Do not stand or pass on both sides and a safe distance shall be kept while the forklift is operating
2. Do not stack packaging boxes more than two boxes high for modules lanscape-oriented packed.
3. Do not stack packaging boxes for modules lanscape-oriented packed.
4. Always choose a flat and rigid ground to ensure that the packing boxes are placed smoothly to avoid falling.

2.1 Unloading

After receiving the modules, please check whether the package is in good condition, and check whether the module model and quantity on the shipping mark are consistent with the delivery note. If any abnormality is found, please contact logistics personnel and HD HYUNDAI sales personnel immediately before unpacking.

2.1.1 Crane Unloading

1. Before hoisting, a special lifting tool with the right tension should be selected according to the weight and size of the module. During hoisting, the position of the hoist sling should be adjusted to keep the gravity of modules on the top of the packing box;
2. If a fixing device is required, please choose the one with same with of the packing box, to prevent the sling from squeezing the packing box, resulting in module damage. Please operate the sling at an even speed, and when the hoist is close to the ground, straighten and place the carton gently on a relatively flat position;
3. Only 4 pallets of modules max. are allowed to be lifted at a time for landscape-oriented packing while 2 pallets of modules max. are allowed to be lifted at a time for portrait-oriented packing;
4. It is strictly prohibited to lift components in severe weather with wind greater than level 6, heavy rain or snow.

2.1.2 Forklift Unloading

1. The height of the loading dock platform should be flush with the bottom of the trailer;
2. Speed control of forklift at straight-line driving <5km/h, turning speed < 3km/h, avoid emergency stop and rapid start;
3. If the packing box blocks the sight of the forklift driver, it is recommended to drive in reverse during transporting, and a special person should be arranged to supervise and command, to prevent the forklift hitting personnel or goods result in personnel injury accidents or damage of modules when the packing box falling;
4. A flat rigid ground should be chosen for placing the modules after transported to the installation site.

2.1.3 General Storage Forklift

1. Choose a forklift with the right tonnage based on the weight of the modules to be lifted. The depth that the forklift blade inserted into the pallet should not be less than three-quarters of the pallet (the length of the forklift blade L3/4 of the pallet length). It is recommended to extend the height or width of the pallet shelf of the forklift blades to prevent the forklift from directly touching the

module glass;

2. In order to ensure better stability when forklifting, adjusting the spacing W between the forklift blades as far as possible to the maximum to prevent forklift scraping the pallet foot pier;
3. Please operate slowly and prohibit the forklift blades from bumping against the carton or pallet.

Place protective buer materials in advance to prevent the modules in the packing box from being damaged due to external forces. Precautions for taking portrait-oriented packing of modules as an example:

- a. Avoid top collision when entering and exiting the container;
- b. It is recommended to use safety rope to fix the modules onto the forklift, keeping the forklift upright during transportation, and no people are allowed to stand on both sides;
- c. Please control the speed to prevent tipping;
- d. Do not touch the module glass;
- e. Do not tilt placement;
- f. Do not touch the component glass;
- g. Do not tilt placement.

2.1.4 Project Site Transfer

Project Site Transfer refers to the transportation of pallets modules between the project storage site and the construction site after modules arrive at the project storage site;

2.1.5 Forklift Truck Specifications:

1. Please use forklift with rated lifting weight _3.5 tons to load and transport modules.

Note: Do not make the raised part of the forklift blade directly contact with the carton or modules, to prevent the modules from being damaged due to the head collision.

2.1.6 Portrait-oriented Packing

1. Forklift blade length (L) 21.0m spacing (W2) adjusted as close as possible to the foot piers on both sides of the pallet;

2. Height (H) of the mast 21.7m with (W1) 1.5m, the mast should be perpendicular to the forklift blade, the mast structure should be strong (can withstand pressure 1.5 tons), when the whole pallet of modules leans on the mast, the mast shall not be deformed due to pressure;
3. Crossbeam;
4. The top beam of the mast should be fixed with buffer materials silicone, rubber, and EPE are recommended at the contact point with the package of modules, so as to prevent the forklift from breaking the modules and profiles.

2.1.7 Landscape-oriented Packing

1. Forklift blade length (L) 1.0m spacing (W2) adjusted as close as possible to the two sides of the pallet foot pier;
2. Mast height (H) 1.5m or width (W1) 2.5m;
3. The mast should be perpendicular to the forklift blades, and the mast structure (can withstand pressure 1.5 tons) should be strong. When the whole pallet of modules leans against the mast, the mast shall not be deformed due to pressure;
4. Crossbeam;
5. The top beam of the mast should be fixed with buffer materials (silicone, rubber, and EPE are recommended) at the contact point with the package of modules, so as to prevent the forklift from breaking the modules and profiles.

Specifications and operation specifications of forklift including but are not limited to the above.

Key precautions to be taken as follows:

1. During forklift transportation, the packing box should be tilted against the forklift mast. Safety rope with tensile strength 2000kgf must be used to fix the modules on the forklift and the driving speed should be controlled to prevent toppling;
2. Put the packing box on the ground smoothly, (no toppling risk) before untying the safety rope;
3. Slowly exit the forklift.

2.2 Storage

Modules should be stored in a dry and ventilated environment and placed on flat ground to avoid breaking or toppling of the package due to deformation or collapse of the ground.

Storage requirements: Humidity <85% and temperature range from -40°C to 50°C

Note:

- a. Do not remove the original package, keep the wrapping film and packing carton intact, if the modules need to be transported for long distances or long term storage;
- b. It is recommended to store the modules to a standard warehouse for long term storage, regular inspection should be performed to check if any abnormal tilting, reinforcing in time if any to ensure personal safety;
- c. The shelves in the warehouse must have sufficient carrying capacity and storage space. Regular inspection should be performed to ensure safe storage of the goods. If modules need to be stored at the project site, do not place them on soft and easy collapsed ground. Rigid ground or ground with high terrain should be selected and leveled to ensure that modules will not collapse or til in long-term storage;
- d. In rainy weather, please use a rain cloth to completely cover the modules and pallets, and rain-proof and moisture-proof measures shall be taken for the pallets and cartons. When there is sunshine or wind, remove the rain cloth to make the outer package dry as soon as possible to avoid collapsing due to moisture deformation;
- e. Do not immerse modules in water. The ground drainage measures should be taken in the storage place at first to prevent the ground from soft and sinking resulted from a large amount of water accumulated after rain;
- f. Unauthorized personnel are prohibited from approaching the module storage area;
- g. Modules should be concentrated stored as much as possible.

3. Unpack

3.1 Precautions

1. Before unpacking, please check the product model, power grade, serial number and relevant suggestions on the A4 paper (mark) of the outer box, and please read the unpacking instructions carefully.

User-defined unpacking is prohibited;

2. Before unpacking, please make sure that the outer packing box is intact. It is recommended to use a utility knife to remove the packing tape and wrapping film. Do not use excessive force to remove the box so as not to scratch the modules in the box;
3. Please check whether the number of modules in the box and the barcode information on the frame are consistent with the shipping mark;
4. Please follow the recommended unpacking procedures to unpack the modules. Modules must always be unpacked by at least 2 people. Always wear insulation gloves when handling the modules;
5. After unpacking, it is recommended to place the remaining un-installed modules horizontally on a pallet and repack them to prevent toppling (stack them one by one with the glass side up when packing). The maximum number of stacked modules should not exceed 16 pieces in one stack;
6. It is necessary to use safety rope to fix the upright modules with the support if the modules are not installed within a short time after unpacking, in high wind weather within grade 6 (less than 12 pieces of modules);

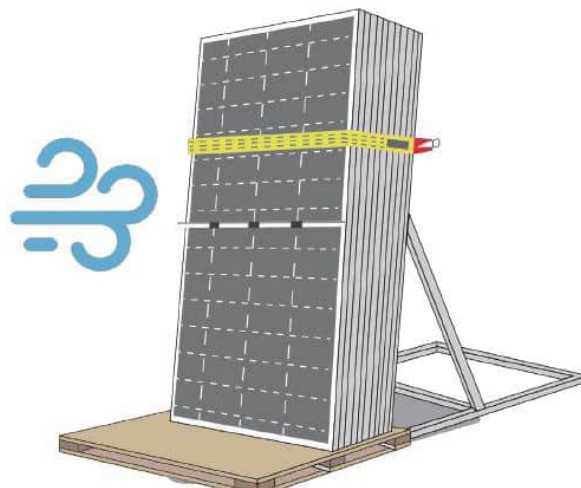

7. Please contact HD HYUNDAI sales personnel in time for requirements related to the module support;
8. In windy weather, do not move the modules, and please fix the unpacked modules properly;
9. Do not perform unpacking outdoor in rainy or snowy conditions;
10. Do not handle modules by one person, to avoid modules sliding and impacting other modules, resulting in scratches, deformation or micro-cracks of modules;
11. Do not pull the junction box or cable with excessive force, so as not to damage the insulation part leading to electric leakage or shock;
12. Before removing the internal packing strap, protection should be taken to prevent the whole box modules from tipping over;
13. Ensure anti-toppling measures will be taken when unpacking landscape-oriented pallets on non-levelled or soft ground;
14. Do not unpack on non-levelled or soft ground since portrait-oriented pallet packing has a high center of gravity, to avoid personal injury or even death;
15. Do not stand on the back of the support when unpacking portrait-oriented pallet packing, please strictly follow the requirements of the unpacking instructions;
16. Pay attention to protection when removing the packing strap for portrait-oriented packing, to avoid scratching the face or eyes and other important parts;
17. No one is allowed to stand on the pallet during unpacking, please handle the modules from both sides of the pallet;
18. It is strictly prohibited to move the support during unpacking to prevent the modules from tipping over;
19. Do not lean modules against the mounting posts;
20. Do not use wooden strips etc. to support the back of the modules directly.

4. Installation

4.1 Fire Safety

1. Prior to installing modules, consult local laws and regulations and follow building fire protection requirements. HD HYUNDAI modules have been qualified for Class C of Fire Rating (as per UL790) according to the corresponding certification standards;
2. The roof shall be roofed with a layer of fire resistant material with appropriate fire rating, and adequate ventilation shall be ensured for the back panels and mounting surfaces. Different roofing structures and mounting methods may affect the fire resistance of a building. Improper installation may result in a fire hazard;
3. In order to ensure the fire rating of the roof, the distance between the module frame and the roof surface must be not less than 10cm;
4. Use appropriate module components such as fuses, circuit breakers, ground connectors, etc. in accordance with local regulations;
5. Do not install modules near exposure to flammable gases.

4.2 Installation Safety

1. Always wear protective headgear, insulating gloves, and safety shoes (rubber soles). Take safety precautions, including but not limited to fall protection, etc.;
2. Never disconnect electrical connections or unplug connectors when the circuit is loaded;
3. When modules are installed on the roof for application, later overall maintenance needs to be considered. The PV system on the roof can only be installed if it has been evaluated by a construction expert or engineer, and that a formal complete structural analysis obtained, and has been verified to be able to withstand additional system support pressures, including the PV module weight;
4. Never disconnect the electrical connection or unplug the connector when the circuit is loaded. Do not insert other metal objects into the connector, or in any other way to make an electrical connection, improper connection can also cause arcing and electric shock. The connectors must

be kept dry and clean to ensure that they are in good working order;

5. Contact with live parts of modules, such as terminals, whether modules connected or not, may result in burns, sparks, and fatal shocks;
6. Do not touch the PV module unnecessarily during installation. Glass surface and the frame may heat up incur burns and electric shock;
7. Do not work in rainy, snowy or windy roof conditions with sand;
8. Avoid exposing cables and connectors to direct sunlight and avoid scratches or cuts to prevent insulation degradation;
9. Only use insulation tools approved for electrical equipment;
10. Keep children away from the system when transporting and installing mechanical and electrical parts;
11. Photovoltaic modules do not have switches. The photovoltaic module can only be stopped by moving it away from the light or shielding it with cloth, cardboard, or a completely opaque material, or by placing the front of the module on a smooth, flat surface;
12. Do not wear metal rings, watchbands, earrings, nose rings, lip rings or other metal objects when installing or troubleshooting the photovoltaic system;
13. Safety regulations (e.g.: Follow safety rules for your area and all other system modules, including wires and cables, connectors, charge regulators, inverters, accumulators, rechargeable batteries, etc.) should be observed;
14. Under normal conditions, photovoltaic modules may produce more current or voltage than its standard test conditions rated power. Therefore, the I_{sc} and V_{oc} values marked on the module should be multiplied by a factor of 1.25 when determining the module voltage class, conductor current class, minimum factor of fuse size, and size of the control output to be connected to the PV;
15. Only use the same connectors to connect the modules in a string, or connect to another device.

4.3 Safe Operation

1. Do not unpack the modules during transportation and storage unless the modules have arrived at the installation site;
2. Protect the package from damage. Do not let the packaged modules in a pallet fall apart;
3. When stacking modules, do not exceed the upper limit marked on the packing box;
4. Keeping the packing boxes in a ventilated, rainproof and dry place before unpacking the modules;
5. Please open the packing boxes according to unpacking Instructions;
6. Do not stand or walk on the modules;
7. Do not drop one module on another;
8. Do not press any heavy objects on the module glass to avoid glass damage;
9. Care must be taken when placing a module on a flat surface, especially in corners;
10. Do not attempt to disassemble the modules, remove the nameplate of the modules, or remove the components from the modules;
11. Do not paint or apply any other adhesive to the surface of the modules;
12. Do not scratch the module back film to avoid back film damage;
13. Do not drill holes in the module frame. This may reduce the loading capacity of the frame and result in corrosion to the frame;
14. Do not scratch the anodized layer on the surface of the aluminum frame, except when connected to ground. Scratches may cause corrosion that affects the loading capacity of the frame;
15. Do not self-repair the modules with back film or glass damaged;
16. Do not damage or scratch the front or back of modules, which may affect the safety of modules.
Do not use such modules in which scratches or cuts are found on the front or back;
17. Do not insert any conductive material into the connector of the module;
18. Do not connect or disconnect modules when they have current or when external current is present;
19. Do not use water to extinguish a fire when the power supply is not disconnected;
20. Any artificial concentrated sunlight shall not be directed onto the PV modules;

21. Do not carry modules on your head;
22. Do not use rope to carry modules;
23. Do not carry modules on your back;
24. The cover of the junction box should remain closed at all times.

4.4 Installation Conditions

4.4.1 Conditions

The module should be installed under the following conditions:

1. Operating environment: -40°C to + 40°C;
2. Humidity: <85RH%;

Note: The mechanical load (including wind and snow load) of modules is subject to the installation method and installation position. When calculating the mechanical load, it must be calculated by professional installers according to the design requirements of the system. Modules should be installed at altitudes below 2000m.

4.4.2 Site Selection

1. Modules should be installed face south in northern latitudes and north in southern latitudes;
2. It is recommended that the modules be installed with an angle of no less than 10°, which allows dust to be washed away by rain for more efficient light intensity and ventilation, as hot air above and below the module can flow in one direction and the module is more efficient at lower temperatures;
3. Refer to the standard solar PV installation guide or consult a professional solar installer and system integrator for details on the best mounting angle;
4. Do not use modules near or in locations where combustible gases may be produced or collected;
5. Modules should not be blocked by buildings, trees, chimneys, etc. during normal operation and use.
6. Modules must not be immersed in water or in an environment that has been exposed to water (pure or salt water) for long periods of time (e.g. fountains, sprays, etc.).

7. There is a risk of corrosion if the modules are placed in an environment containing salt spray (i.e. marine environment) or sulfur (i.e. sulfur sources, volcanoes, etc.).
8. The module and its connectors must not be exposed to unauthorized chemicals (e.g., lubricating oils, pesticides, etc.), which can cause damage to the component.
9. If the module needs to be installed in the offshore environment, please evaluate and confirm with the HD HYUNDAI technical team in advance before purchasing. In general, the module can be installed on land 50-500m away from the sea, but when installing the module in the area within this distance, the connector needs to be protected or added with a dust plug, which must be connected immediately after removing the dust plug, and other anti-rust measures to prevent the relevant parts from rusting.

4.5 Mechanical Installation of Components

4.5.1 General Requirements

1. All installation methods set forth in this manual are for reference only, HD HYUNDAI is not responsible for providing the relevant installation parts, design and installation of module system. Mechanical loading and safety shall be done by professional system installers or experienced personnel;
2. The distance between two adjacent modules on the left and right should be within 50mm; For two adjacent solar arrays, the distance between each module should be within 25mm, in order to meet system wiring requirements;
3. Before installation, the following precautions should be taken:
 - a. Modules should be checked visually for any damage and they should be cleaned if there is any dirt or residue left during transporting;
 - b. The module serial numbers should also be checked to ensure they're correct;
4. The mounting tracker of module shall be constructed of durable, corrosion-resistant, and UV-resistant materials;
5. In areas with heavy snow cover in winter, a taller mounting tracker should be selected. In this way, the lowest point of the module will not be covered by snow for a long time. In addition, the

lowest point of the module is high enough to prevent the module from being obscured by plants and trees, or from being damaged by flying rocks;

6. It is not allowed to drill holes on the glass and frame of the modules without HD HYUNDAI' s permission;
7. Ensure that the back sheet of the module does not touch the support or building structure that can access the interior of the module, especially when there is external pressure applied on the module surface;
8. The PV module of HD HYUNDAI HJT is recommended to use the recommended installation method. Different installation methods will affect the maximum load of the module. Please see the following table for details: ' module installation method and corresponding load ' ; The load data is the mechanical load measured in the laboratory. The design load of the project needs to reserve 1.5 times the safety factor, that is: $\text{design load} = \text{test load} / 1.5$. If the modules are installed in such environment as snowy or strong wind, special protection should be taken during the installation to meet the actual requirements;

4.5.2 Bolt Type Mounting

Modules are bolted to the supporting structure through the mounting holes in the rear frame of modules.

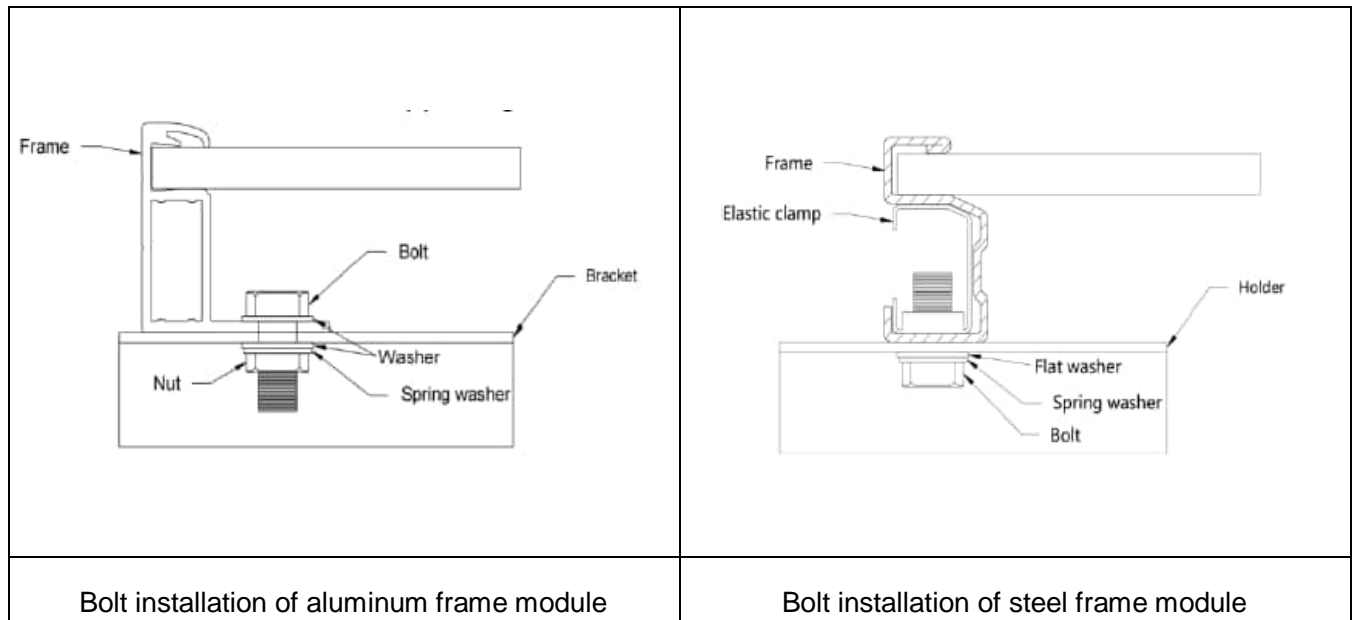

There are multiple installation holes on the back frame of the module, and at least four installation holes need to be symmetrically secured for bolt-on module.

The 9 * 14mm specification installation holes on the back of the frame are fixed with M8 bolts, and the 7 * 10mm installations holes are fixed with M6 bolts.

It is recommended to use 1 outer hexagonal bolt + 2 flat washer + 1 spring washer + 1 hexagonal nut collocation for bolt installation of aluminum frame modules. The fastener material is recommended to be SUS304.

It is recommended to use 1 bolt+ flat washer + 1 spring washer + 1 elastic clamp for bolt installation of steel frame modules. The material of elastic clamp is S350 GD. If this installation method is used in the project site, please contact HD HYUNDAI to sell and purchase the elastic clamps.

*The material and selection of fasteners can be selected according to the actual environment of the project.

*Suggestion: tightening torque for M8 bolts should be within 16N•m-20N•m; The torque for M6 bolts should be within 8N•m-12N•m.

4.5.3 Clamp Type Mounting

The modules should be installed using special clamp.

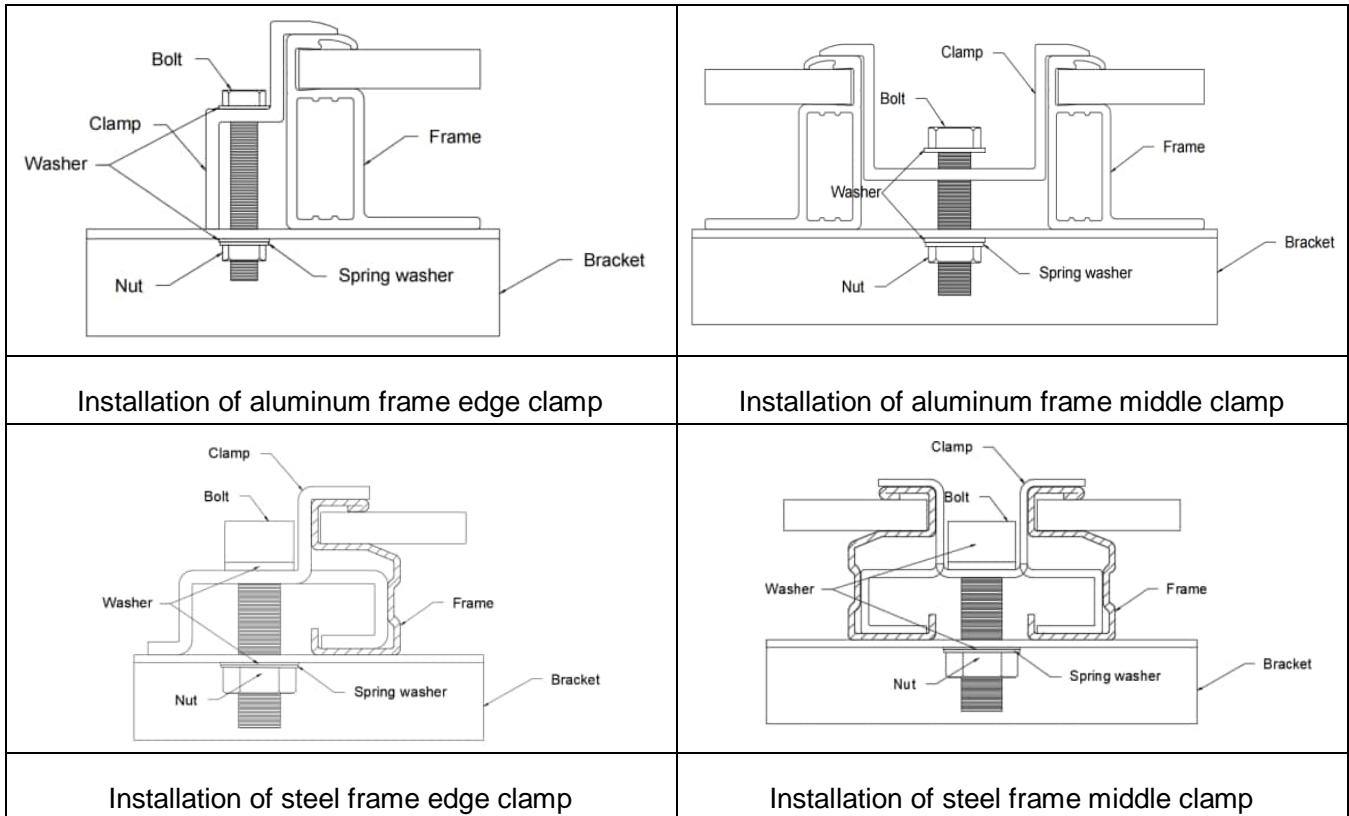

The use of clamp installation modules requires the use of at least four clamps symmetrically fixed modules; the middle clamp can be used to fix the two adjacent modules, and the edge of the group string can be fixed by the edge clamp. Always make sure the shadow of clamps should not come on the module front surface. The drain hole should not be blocked by clamps. For framed modules, ensure the clamps overlap the module frame by at least 8mm but not more than 10mm (cross section of clamps can be changed, on the condition that the modules may be installed securely).

It is recommended to use the combination of 1 clamp + 1 bolt + 2 flat washer + 1 spring washer + 1 nut for the installation of the clamps. The fastener material is recommended as SUS304 ; clamps should be the same material with the frame, aluminum frame clamps material recommended 6005-T6, recommended aluminum frame clamps length $\geq 60\text{mm}$, thickness $\geq 3\text{mm}$; steel frame clamps material recommended S350GD, steel frame clamps length $\geq 100\text{mm}$, thickness $\geq 2\text{mm}$.

* The material and type of clamps and fasteners can be selected according to the actual environment

of the project site.

Under no circumstances should the clamps touch the glass or deform the frame of the module. The front contact surface between the clamp and the frame must be smooth, otherwise the frame may be damaged and result in the damage of the module.



* Suggestion: Tighten with M8 bolts, torque range: 16N.M-20N.M.

4.5.4 Module installation diagram and corresponding load

Under the effect of gravity or small load, the glass surface of the module will have different degrees of subsidence, and the center of the module will have the largest amount of subsidence, which is the elastic deformation. The deformation can be restored after taking down the module or removing the load, which will not result in micro-crack of cells and power degradation.

Module appearance may get affected under severe environment such as heavy snow, module will bear heavy snow load, a big shape change may occur to the center of the module. During the shape change of modules, the junction box or the glass may contact with the obstacle underneath, great stress may occur to the back glass and the modules are vulnerable to break. HD HYUNDAI requires that the distance between the obstacle underneath and the junction box or the glass shall $\geq 120\text{mm}$. When installing the clamps on the short side, the load should be calculated and the support structure designed by professional structural engineers, according to the project climate conditions. Any foreign matters should be avoided underneath the orthographic projection of the module glass. Other appearance issues resulted from self-weight or other loads are not deemed as defects, and which will not be covered under warranty.

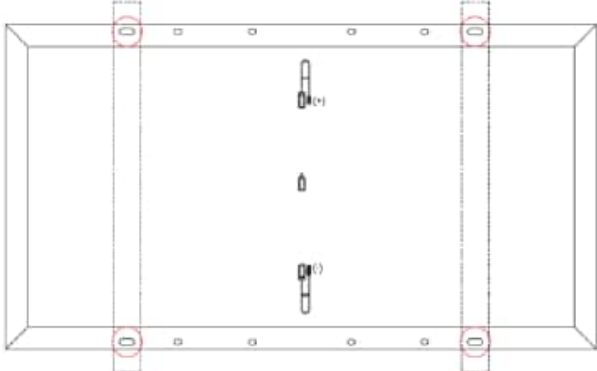
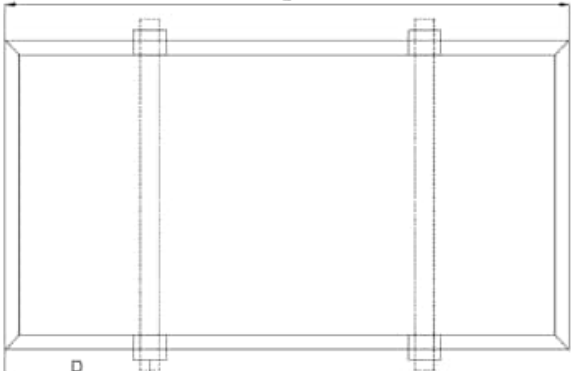
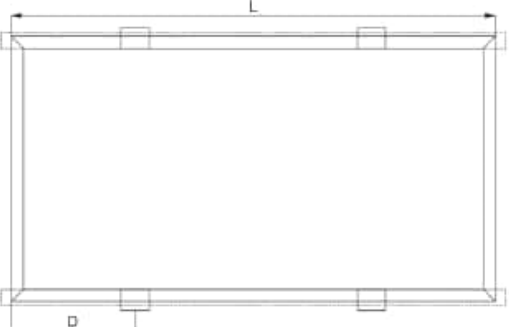
Clamps installation diagram

	
<p>IM1.Outer four hole bolt installation (guide rail perpendicular to the long frame)</p>	<p>IM2.Long side clamp (guide rail perpendicular to the long side frame)</p>
	
<p>IM3.Long side clamp (guide rail parallel to the long side frame)</p>	<p>IM4.Four-angle clamp (no guide rail)</p>
	
<p>IM5.Short side clamp (guide rail perpendicular to the long side)</p>	

The installation method corresponds to the load

Module Model	The installation method corresponds to the load						
	IM1	IM2			IM3	IM4	IM5
		D=450±50mm	D≤200mm	1/5≤D≤1/4L	1/5≤D≤1/4L	30mm≤D≤1/4L	1/5≤D≤1/4L
HiT-HxxxOI	+5400 -2400	/	/	+5400 -2400	+3600 -2400	/	/
HiT-HxxxCE-BF HiT-HxxxCE-BF(ZB) HiT-HxxxCE-BFT HiT-HxxxCE-BFT(ZB) HiT-HxxxCE-FB HiT-HxxxCE-FB(ZB) HiT-HxxxLE-FB HiT-HxxxLE-FB(ZB)	+5400 -2400	/	+2400 -2400	+5400 -2400	/	+1600 -1600	+2000 -2000
HiT-HxxxCF-BF HiT-HxxxCF-BF(ZB) HiT-HxxxCF-BFT HiT-HxxxCF-BFT(ZB) HiT-HxxxCF-FB HiT-HxxxCF-FB(ZB) HiT-HxxxLF-FB HiT-HxxxLF-FB(ZB)	+5400 -2400	/	/	+5400 -2400	/	+1600 -1600	+1800 -1800
HiT-HxxxCH HiT-HxxxCH-ZB	+5400 -2400	/	/	+5400 -2400	/	/	/
HiT-HxxxGH HiT-HxxxGH-ZB	+5400 -2400	/	/	+5400 -2400	+3600 -2400	/	/
HiT-HxxxGG	+5400 -2400	/	/	+5400 -2400	/	/	/

Module Model	The installation method corresponds to the load					
	IM2			IM5		
	D=450±50mm	D≤200mm	1/5≤D≤1/4L	60≤A≤200mm	200≤A≤250mm	Clamps on four corners
HiT-HxxxMF-FB HiT-HxxxOF-BF HiT-HxxxOF-BFT HiT-HxxxOF-FB	+5400 -2400	/	/	±1800	±2000	±1600

4.5.5 Tracking System Installation

Module can be installed on the tracking system such as the flat single axis. The installation holes should be selected according to the design of the support system. Refer to the table below for the installation methods and corresponding mechanical load. The system installer or professional designer should check the bearing capacity of the support system (bracket, foundation, etc.) according to the selected mounting holes position or clamp position. All losses caused by design changes or installation errors of the tracker manufacturer may not be covered by HD HYUNDAI warranty.

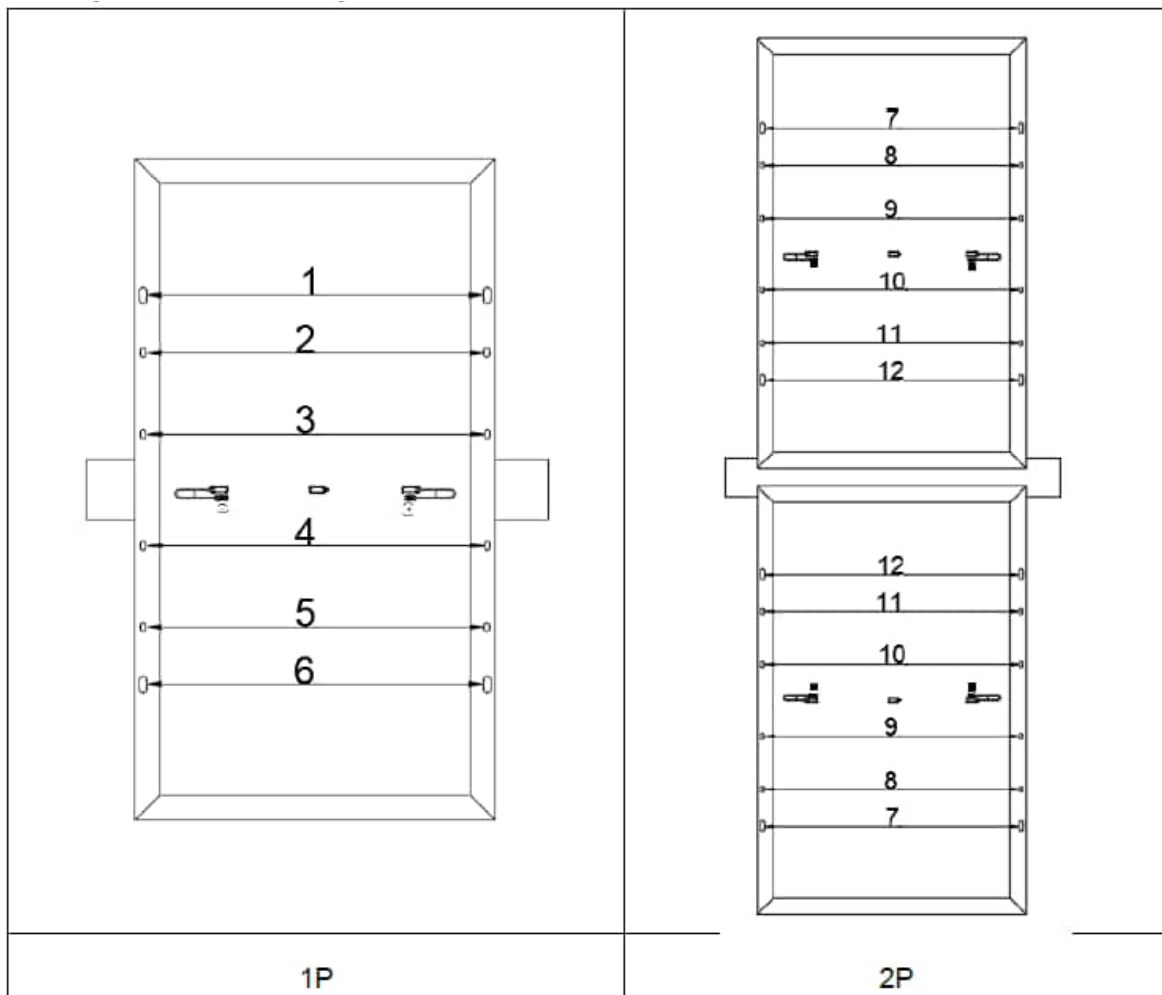

Modules with tracking system load list

Module Model	Bracket Model	Installation Hardware	test load (Pa)
HiT-HxxxOI	NEXTTracker NXH/NX100/NXH-XTR (1P)	NX Standard Rail (400mm) 3、 4 installation hole	+1400 -1400
		NX Standard Rail (790mm) 2、 5 installation hole	+2200 -2200
		NX Standard Rail (1400mm) 1、 6 installation hole	+2600 -2600
HiT-HxxxCH HiT-HxxxCH-ZB	NEXTTracker NXH/NX100/NXH-XTR (1P)	NX Standard Rail (400mm) 3、 4 installation hole	+1600 -1600
		NX Standard Rail (790mm) 2、 5 installation hole	+3600 -2400
	Soltec SFOne (1P)	Standard Short Rail 3、 4 installation hole	+1800 -1500
		Long Rail 2、 5 installation hole	+2000 -1500
		Long Rail 1、 6 installation hole	+2500 -2000
	Soltec SF7 (2P)	Long Rail 8、 11 installation hole	+2200 -1500
		Long Rail 7、 12 installation hole	+2600 -2000
		Standard Short Rail 9、 12 installation hole	+1800 -1500
	Arctech horizontal Single-axis Tracker SkyLine 2.5(1P)	450mmpurlin Drawin No:300025853 3、 4 installation hole	+1800 -1800
		840mmpurlin Drawin No:300025616 2、 5 installation hole	+2300 -2000
		1450mmpurlin Drawin No:300025276 1、 6 installation hole	+2500 -2100
	HiT-HxxxGH HiT-HxxxGH-ZB	NEXTTracker NXH/NX100/NXH-XTR (1P)	NX Standard Rail (400mm) 3、 4 installation hole
NX Standard Rail (790mm) 2、 5 installation hole			+2800 -2400
Soltec SFOne (1P)		Standard Short Rail 3、 4 installation hole	+1800 -1500
		Long Rail 2、 5 installation hole	+2000 -1500
		Long Rail 1、 6 installation hole	+2500 -2000
Soltec SF7 (2P)		Long Rail 8、 11 installation hole	+2200 -1500
		Long Rail 7、 12 installation hole	+2600 -2000
		Standard Short Rail 9、 12 installation hole	+1800 -1500
Arctech horizontal Single-axis Tracker SkyLine 2.5(1P)		450mmpurlin Drawin No:300025853 3、 4 installation hole	+1800 -1800
		840mmpurlin Drawin No:300025616 2、 5 installation hole	+2300 -2000
		1450mmpurlin Drawin No:300025276 1、 6 installation hole	+2500 -2100

5. Electrical Installation

5.1 Electrical Performance

1) There is an error of $\pm 3\%$ between the nominal value of module electrical performance parameters such as I_{sc} , V_{oc} , P_{max} and standard testing conditions rated value;

Standard test conditions of modules: front irradiance $1000\text{W}/\text{m}^2$, atmospheric quality AM1.5, module temperature 25°C (STC);

Front irradiance $1000\text{ W}/\text{ m}^2$, back irradiance $135\text{ W}/\text{m}^2$, atmospheric quality AM1.5, module temperature 25°C (BNPI);

2) The maximum allowed quantity of modules in string connection shall be calculated according to relative regulations. The open circuit voltage value under the expected lowest temperature shall not exceed the maximum system voltage value allowed by modules and other values required by DC electric parts. Normally, the VOC factor can be calculated by the following formula. $C_{Voc} = 1 - \beta (V_{oc} \times (25 - T))$. T: The expected lowest temperature of the installation site, β : VOC temperature coefficient ($\%/^\circ\text{C}$) (Refer to modules data sheet). Recommended maximum value in series is $[\text{Max System voltage } V / (1.25 \times V_{oc})]$, recommended maximum value in parallel is $[\text{fuse rating current} / 1.25 \times I_{sc}]$;

3) In order to ensure the normal operation of the system, when connecting modules or connecting loads, the polarity connection of the cable should be ensured to be correct; If the module is not connected correctly, the bypass diode and the cable box may be damaged. PV modules are connected in series, parallel and series-parallel, etc. The number of modules connected in series and parallel should be reasonably designed according to the system configuration. When the number of modules in parallel is more than 2 strings, the current protection device must be used on each string of modules.

4) The modules in series must use the same specification module products, and the modules in the same string must ensure the consistency of their current.

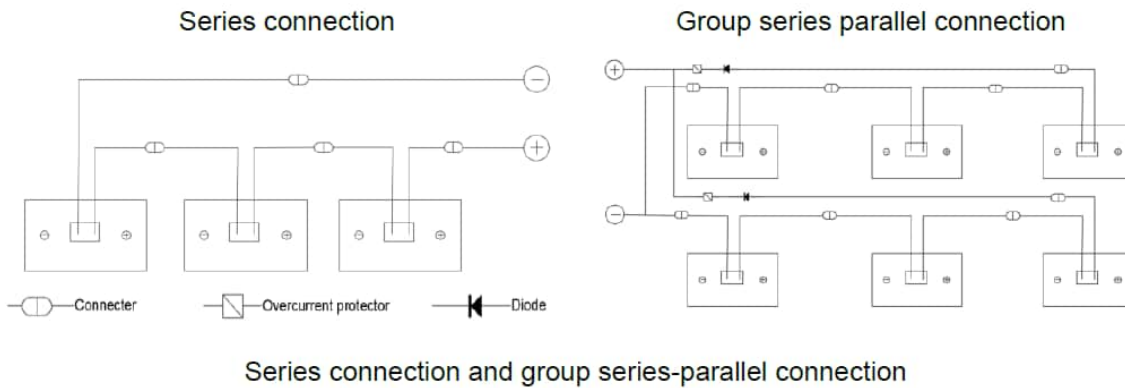

5.2 Cables

- 1) The connector used in the module requires protection level IP68, connector protection level IP68. The positive electrode of the module connector is inserted into the negative electrode of the connector of the adjacent module for series connection.
- 2) Always use dedicated solar cables that comply with local fire, building and electrical regulations;
- 3) Only use the special cable that minimum 90°C temperature resistant, light resistant with a cross section not less than 4mm² designated as PV wire for field application. It is recommended to use 4-6mm² PV special cables in the roof tile installation;
- 4) HD HYUNDAI requires that all wiring and electrical connections shall comply with the corresponding requirements of the National Electrical Code;
- 5) Use light-resistant cable ties and cable clips to fix cables on brackets or mounting rails to avoid blocking the back of modules;
- 6) Cables should be protected from direct sunlight or water. Do not press hard on the cable which may result in mechanical damage;
- 7) The minimum bending radius of the cable should be 43mm.

5.3 Connectors

- 1) Please keep the connector dry and clean, and make sure that the nut of the connector

is in a tight state before connecting.

- 2) Avoid foreign objects such as moisture, dust, and organisms from entering the connector, which may cause the connector to fail to work properly or be damaged.
- 3) If the connector is in a wet state, it is forbidden to connect.
- 4) If the connector is polluted, it is forbidden to connect and use.
- 5) If the connector is not connected positively and negatively, the connector does not have waterproof function.
- 6) The components need to be connected as soon as possible after installation, and the connector should meet the requirements of IP68 (IEC60529) after connection. If the connector cannot be connected in time or installed in rainy and foggy weather, it is recommended to increase the connector protection device.
- 7) Avoid the connector being exposed to direct sunlight and soaking in water.
- 8) Avoid the connector falling on the ground or roof, the wrong connection may produce arc and electric shock, please make sure all the electrical connections are firm, make sure all the connectors with locking are fully connected.
- 9) Do not connect different (brand and model) connectors together.



5.4 Bypass Diode

In case of diode failure, please contact HD HYUNDAI promptly and do not open the junction box by your-self.

5.5 Anti-pid and Inverter Compatibility

HD HYUNDAI PV modules are certified with the most rigorous PID testing before leaving the factory. The negative electrode of the modules usually does not need to be electrically connected to the earth, so it can be compatible with isolated type (with transformer) or non-isolated type inverters.

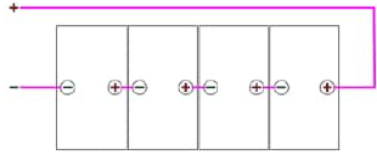
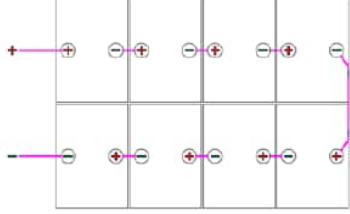
5.6 Cable method

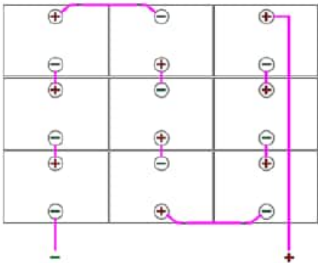
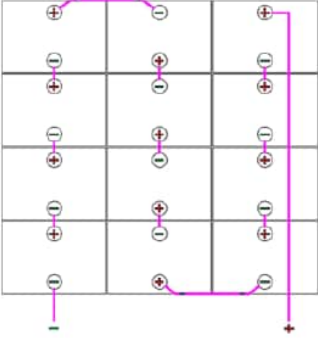
<p>vertical installation of modules: Select standard short cable</p>		
<p>Cross- installation of modules: Select standard long cable</p>		
<p>Cross- installation of modules: Select standard short cable</p>		

6. Grounding

(1) Module frame should be grounded to avoid lightning strikes and for electrical safety. It can be connected by using 4mm² copper core wire threaded through the adjacent ground hole on the module frame. If there is no ground hole, you can also use the unused mounting hole on frame for the grounding;

(2) When grounding, the screw must penetrate the anodized coating of the frame and it should be tightened to secure.

(3) The grounding conductor or grounding wire may be copper, copper alloy or any other material used as an electrical conductor that meets the requirements of the corresponding National Electrical Code, and the grounding conductor must be connected to the earth by a suitable grounding electrode;

(4) The following grounding methods are permitted:

① Use a grounding clamp for grounding

a. There is an Ø 5mm diameter ground hole in the middle near edge on the back frame of the module.

b. Pre-install the grounding device according to the schematic diagram.

c. Lock the grounding bolt, the recommended torque value for the M3 grounding bolt is 2.3N-m.

d. The grounding between the modules should be done by a qualified electrician and the grounding device must be made by a qualified electrical manufacturer.

e. The service life of grounding accessories should meet the requirements of the project.

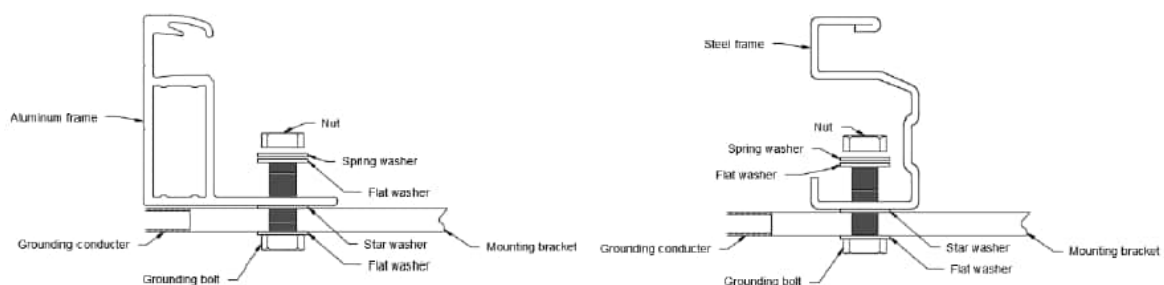

② Other third party grounding devices

Modules may be grounded using a third party grounding device, but the grounding must be reliable and certified, and the grounding device is operated in accordance with the manufacturer's requirements.

7. Operation and Maintenance

Regular inspection and maintenance of modules must be carried out, especially within the warranty period, which is the user's responsibility. The circuit breaker should be disconnected before the inspection. If modules are damaged, the supplier should be informed within two weeks after the failure found, and the same type of modules should be used for replacement. Do not touch the live parts of the cable or the connector.

7.1 Cleaning

1) Dust accumulation on the glass surface of the module will reduce its power output and may cause regional hot spots such as industrial wastewater and bird droppings. The degree of impact depends on the transparency of the waste. The modules should be cleaned regularly since a small amount of dust on the glass will affect the intensity and uniformity of sunlight absorbed.

2) Cleaning may create a risk of damaging the modules and relevant components, as well as increasing the potential electric shock. Therefore, care should be taken to protect the modules from damage by wearing appropriate protective clothing such as clothes, insulating gloves;

3) Before cleaning, inspect modules for cracks, damage and loose connections;

Make sure the circuit is disconnected before cleaning the modules as touching exposed parts of live parts may cause injury;

4) In order to reduce potential electric shock or burn, it is recommended to clean photovoltaic modules in the early morning or evening when the light is not strong and the

module temperature is low, especially for areas with higher temperatures;

5) Do not try to clean photovoltaic modules with broken glass or exposed wires, which may result in electric shock;

6) As for the frequency of cleaning, it depends on how quick the dirt accumulates. Under normal circumstances, rain will clean the surfaces of modules, which will reduce the frequency of cleaning;

7) Under no circumstances should a material with a rough surface be used to clean modules.

a. Cleaning methods

① Method A: High-Pressure Water Cleaning

② Water quality requirements

③ PH: 5-7

④ Chloride or salt content: 0-3000 mg/L

⑤ Turbidity: 0-30 NTU

⑥ Conductivity: 1500~3000 us/cm

⑦ Total dissolved solids (TDS): ≤1000mg/L

⑧ Water hardness - Calcium and magnesium ions: 0-40mg/L

⑨ Non-alkaline water must be used, softened water should be used when available.

⑩ The recommended maximum water pressure is 4MPa (40bar)

b. Method B: Compressed Air Cleaning

Air pressure cleaning is recommended when cleaning soft stains (like dust) on modules.

This method can be applied as long as the field cleaning is efficient enough.

c. Method C: Wet Test Cleaning

① If there is excessive soiling present on the surface of modules, an insulated brush, sponge, or other soft cleaning tool may be used with caution.

② Ensure that any brushes or agitating tools are made of insulating material to minimize the risk of electric shock and that they do not scratch the glass or aluminum frame.

③ An environmentally friendly cleaner may be used discreetly if oil stains are present.

d. Method D: Cleaning Robot Cleaning

① If the cleaning robot is used for dry cleaning, it is required that the brush material is soft plastic, and the glass surface and aluminum alloy frame may not be scratched during and after cleaning.

② The weight of the cleaning robot should not be too heavy, and module damage and power degradation caused by improper cleaning of the cleaning robot are not within the warranty of HD HYUNDAI.

7.2 Visual Inspection of Modules

Visually inspect the modules for appearance defects, in particular:

- 1) Whether the glass of the module has cracked;
- 2) Corrosion in the soldering of the cell main bus bar: during installation or transportation, the encapsulation material is damaged, resulting in moisture into modules;
- 3) Check the back sheet of modules for burning marks;
- 4) Check the photovoltaic modules for signs of aging, including possible rodent damage, climate aging, and whether all connectors are tightly connected and corroded. Check and make sure the modules are well grounded;
- 5) Ensure that there is no sharp object in contact with the surface of the module;
- 6) Whether the module is blocked by obstacles, foreign bodies;
- 7) Check whether the fixing screws between the module and the bracket are loose or damaged, and adjust or repair them in time.

7.3. Inspection of Connectors and Cables

It is recommended to perform a preventive inspection every 6 months as follows:

- 1) Check the tightness of the connectors and whether the cable connection is secured;
- 2) Check for cracked sealant and gaps at the junction box.

3) Check whether all connectors are tightly connected and whether there is any corrosion; Check connectors, bolt torque, and grounding; Check that the installed hardware is fastened in place, loose connections can cause damage to the array.

4) All cables are inspected for rodent damage or material aging to verify the robustness of their connections. In addition, the connector should be protected from direct sunlight and away from waterlogged areas.